

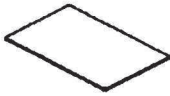











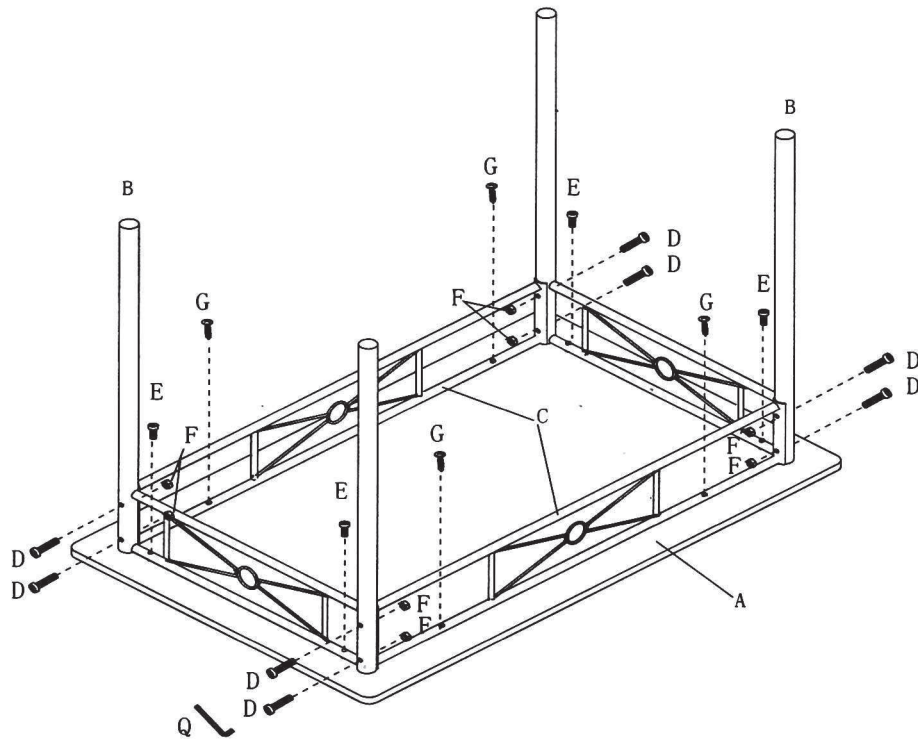
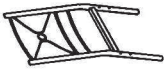

<b>A</b>  <b>X1</b>		<b>B</b>  <b>X2</b>	<b>C</b>  <b>X2</b>
<b>D</b>  <b>X8</b> <b>M6*40</b>	<b>E</b>  <b>X4</b> <b>M6*25</b>	<b>F</b>  <b>X8</b> <b>M6</b>	<b>G</b>  <b>X4</b> <b>ST4*25</b>



<p><b>H</b></p>  <p><b>X4</b></p>	<p><b>I</b></p>  <p><b>X4</b></p>
<p><b>J</b></p>  <p><b>X8</b></p>	<p><b>K</b></p>  <p><b>X4</b></p>
<p><b>L</b></p>  <p><b>X4</b></p>	<p><b>M</b></p>  <p><b>X16</b> <b>M6*40</b></p>
<p><b>N</b></p>  <p><b>X8</b> <b>M6*35</b></p>	<p><b>O</b></p>  <p><b>X8</b> <b>M6*30</b></p>
<p><b>P</b></p>  <p><b>X16</b> <b>M6*45</b></p>	<p><b>Q</b></p> 