

Pozitie	Cant.	Descriere	Preț unitar
	1	<p data-bbox="282 161 527 193">ALPHA2 L 25-40 180</p>  <p data-bbox="672 590 1203 615">Notă! Poza de produs poate diferi de produsul actual</p> <p data-bbox="282 646 527 674">Nr. Produs: 95047562</p> <p data-bbox="282 701 824 758">GRUNDFOS ALPHA2 L The next generation of A-labelled small circulators</p> <p data-bbox="282 816 1146 844">ALPHA2 L is the latest member of the Grundfos family of high-quality circulators.</p> <p data-bbox="282 873 1068 900">With ALPHA2 L, you can stop worrying about complicated pump settings.</p> <p data-bbox="282 930 1256 987">ALPHA2 L is flexible, reliable, and more compact than any other A-labelled circulator pump on the market.</p> <p data-bbox="282 1016 1252 1125">Compact design The innovative design makes ALPHA2 L the most compact Grundfos circulator available. With the electronics integrated in the pump housing, installation in very confined spaces is now possible.</p> <p data-bbox="282 1155 1273 1264">A-label The frequency converter, permanent-magnet technology, and compact stator place ALPHA2 L highest on the energy label scheme. ALPHA2 L will use up to 80 % less electrical energy than D-labelled circulators.</p> <p data-bbox="282 1293 1281 1377">ALPHA plug The much appreciated and very popular ALPHA plug is the only plug in the market that offers extremely simple cable connection.</p> <p data-bbox="282 1407 846 1463">One-touch operation Intuitive one-touch operation enables simple setting.</p> <p data-bbox="282 1522 777 1606">Liquid: Gama temperaturii lichidului: 2 .. 110 °C Densitate: 1000 kg/m3</p> <p data-bbox="282 1635 781 1722">Technical: Clasa TF: 110 Aprobări pe etichetă: VDE,GS,CE</p> <p data-bbox="282 1751 824 1894">Materials: Corpul pompei (stator): Fontă EN-JL 1020 ASTM A48-25 B Rotor: Compozit, PP</p> <p data-bbox="282 1923 748 2089">Instalație: Gama temperaturii ambientale: 0 .. 40 °C Presiune de funcționare maximă: 10 bar Racordarea pompei la instalație: G 1 1/2 Presiune maximă de funcționare: PN 10 Distanța dintre porturi: 180 mm</p>	Preț la cerere

Pozitie	Cant.	Descriere	Preț unitar
		<p>Electrical data:</p> <p>Power input - P1: 5 .. 22 W</p> <p>Curent consumat maxim: 0.05 .. 0.19 A</p> <p>Frecvența rețelei electrice: 50 Hz</p> <p>Tensiune nominală: 1 x 230 V</p> <p>Grad de protecție (IEC 34-5): 42</p> <p>Clasă de izolare (IEC 85): F</p>	

Descriere	Valori și tipuri
Nume produs:	ALPHA2 L 25-40 180
Nr. produs:	95047562
Numărul EAN:	5700311668573
Technical:	
Înălțime de pompare max.:	40 dm
Clasa TF:	110
Aprobări pe etichetă:	VDE,GS,CE
Materials:	
Corpul pompei (stator):	Fontă EN-JL 1020
	ASTM A48-25 B
Rotor:	Compozit, PP
Instalație:	
Gama temperaturii ambientale	0 .. 40 °C
Presiune de funcționare maximă	10 bar
Racordarea pompei la instalație:	G 1 1/2
Presiune maximă de funcționare:	PN 10
Distanța dintre porturi:	180 mm
Liquid:	
Gama temperaturii lichidului	2 .. 110 °C
Densitate:	1000 kg/m ³
Electrical data:	
Power input - P1	5 .. 22 W
Curent consumat maxim:	0.05 .. 0.19 A
Frecvența rețelei electrice:	50 Hz
Tensiune nominală:	1 x 230 V
Grad de protecție (IEC 34-5):	42
Clasă de izolare (IEC 85):	F
Tip protecție motor încorporată:	FĂRĂ
Protecție termică:	ELEC
Controls:	
Poziția cutiei de conexiuni:	6H
Others:	
Greutate netă:	2.1 kg
Greutate brută:	2.3 kg
Etichetă energie:	A

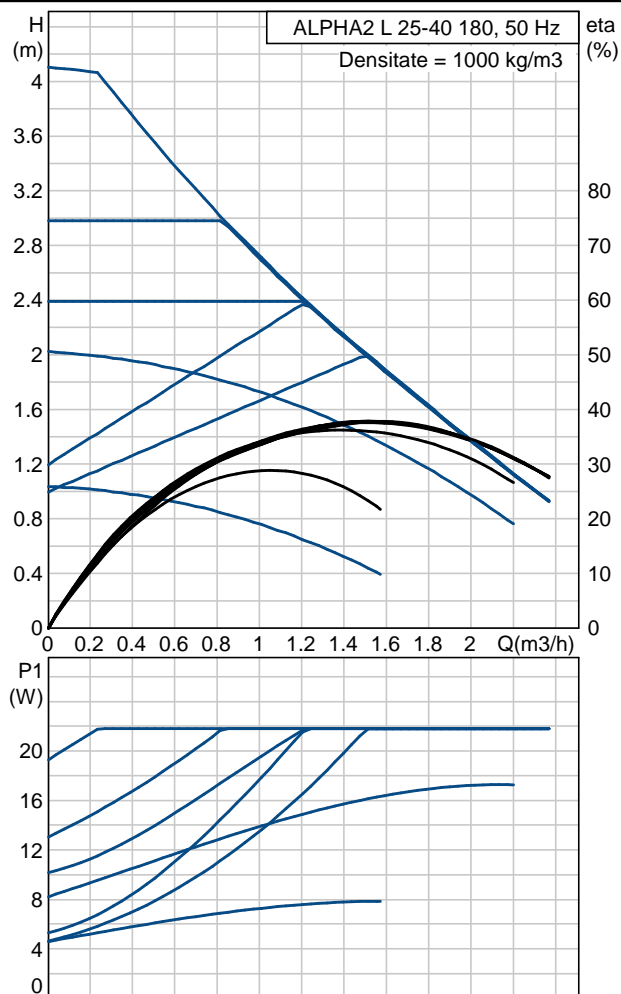

95047562 ALPHA2 L 25-40 180 50 Hz

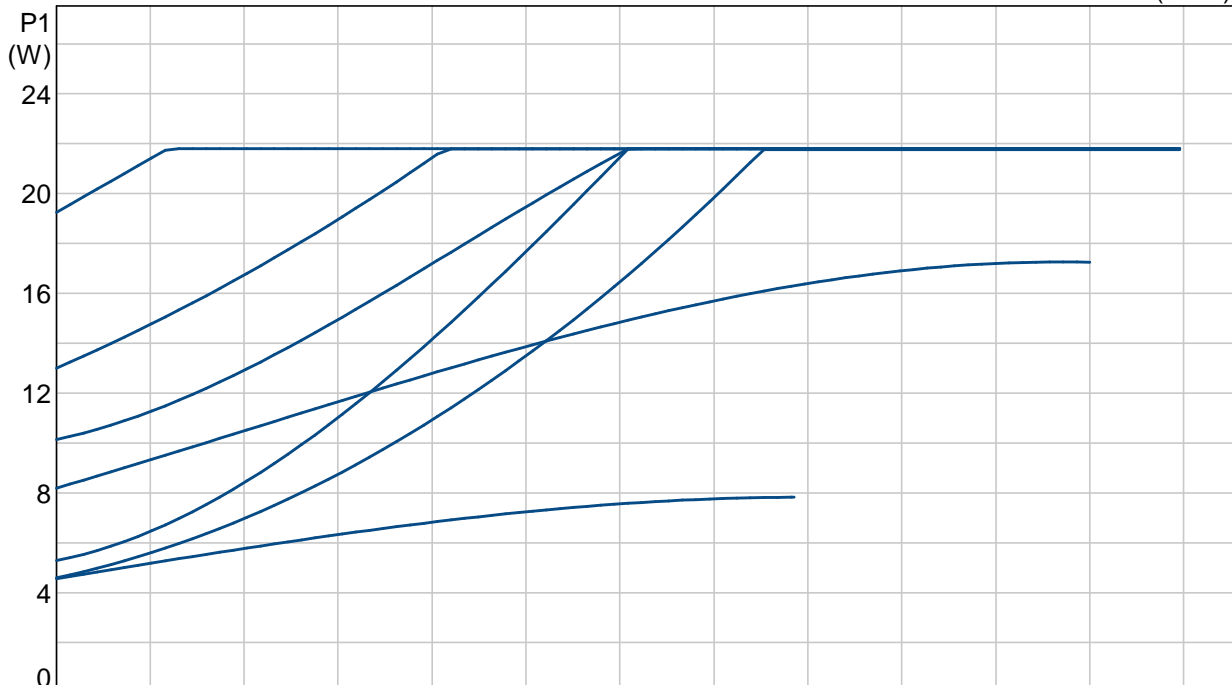
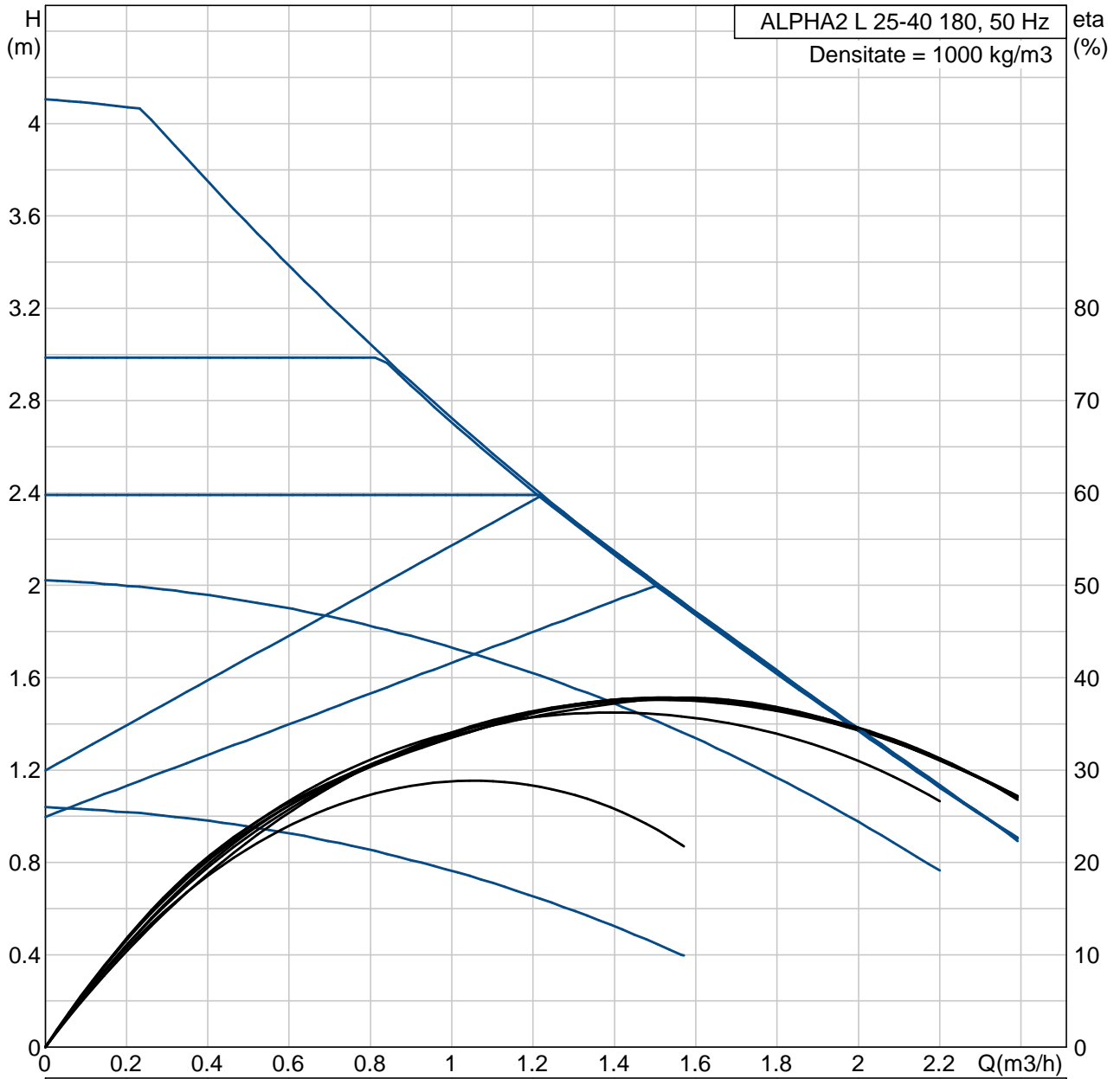

95047562 ALPHA2 L 25-40 180 50 Hz

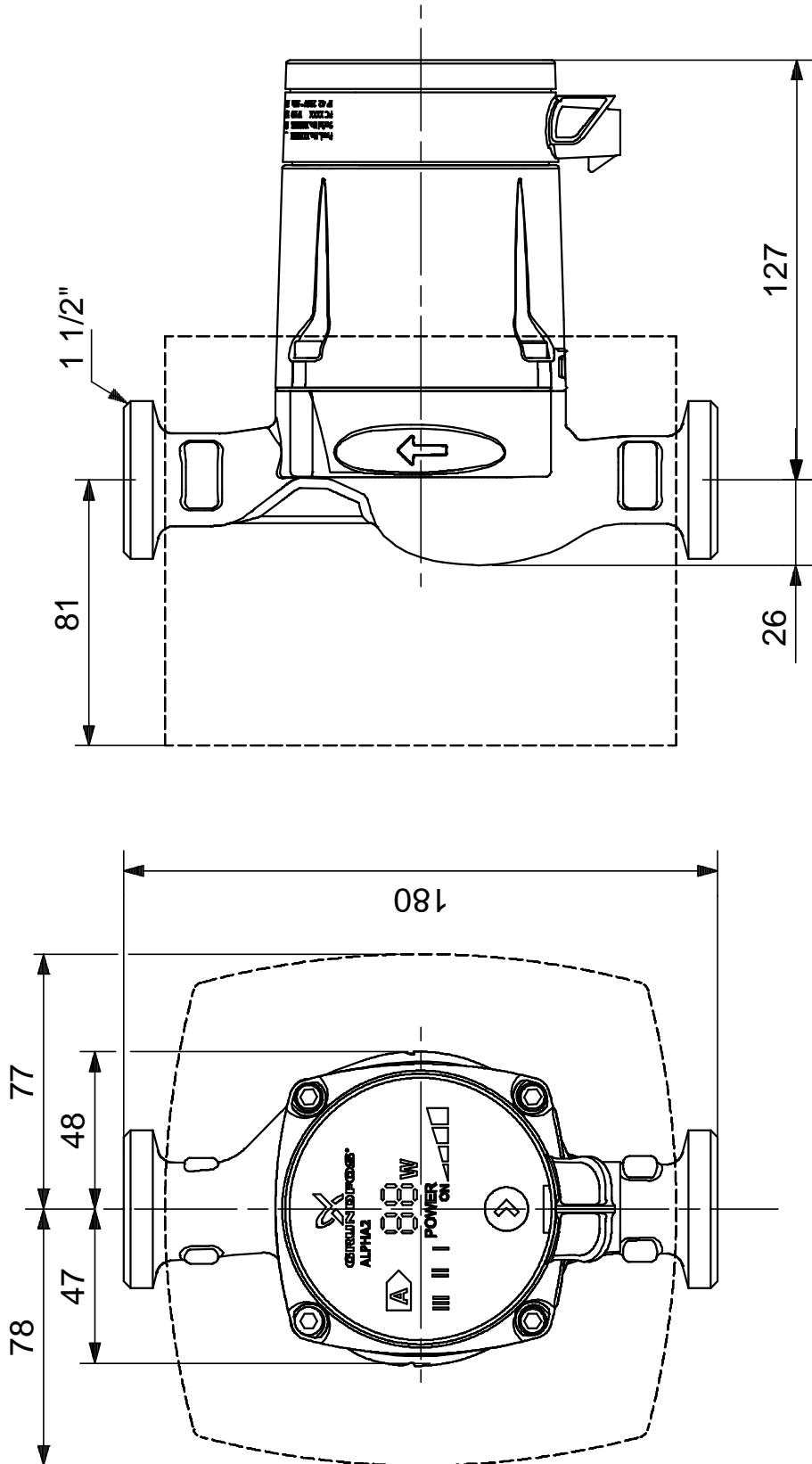

Note! All units are in [mm] unless others are stated.
Disclaimer: This simplified dimensional drawing does not show all details.

95047562 ALPHA2 L 25-40 180 50 Hz

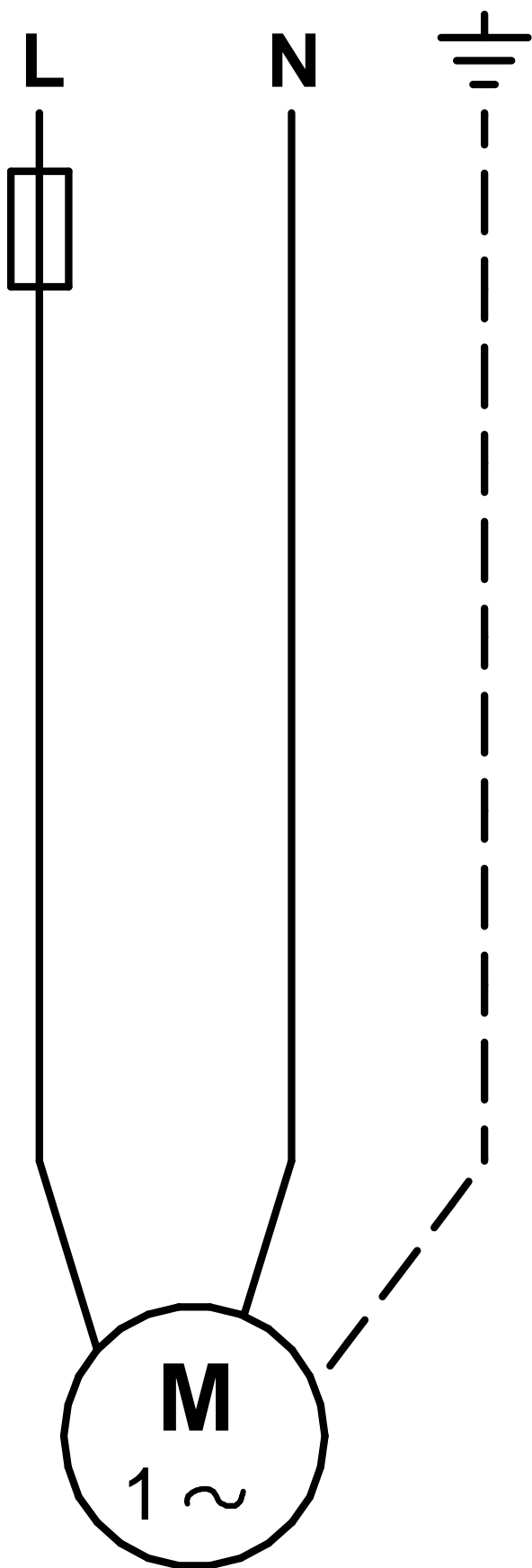

Notă! Toate unitățile sunt în [mm] dacă nu altele sunt condițiile.