

FISA DE MONTAJ

T 15. PAT

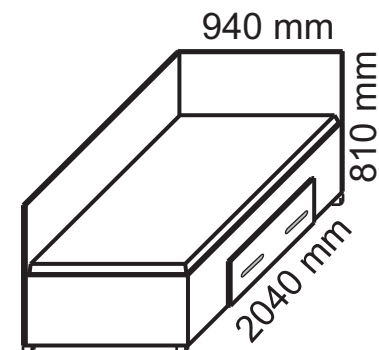

PASUL 1:

Se prind legaturile (3) de lateralele (1 si 2) prin eurosuruburi folosind cheia imbus inclusa in pachet. Astfel se va obtine un cadru suport. Cadrul exterior al patului este realizat prin prinderea cu eurosuruburi a lateralelor (5,7) de capacul mare (4) si de capacul mic (6).

PASUL 2:



Se vor monta piciorusele cui pe cadrul exterior. Se pozitioneaza cadrul suport in interiorul cadrului exterior si se va aseza protectia (14) pe cadrul suport in interiorul patului, urmand ca pe aceasta protectie sa se puna salteaua.

PASUL 3:

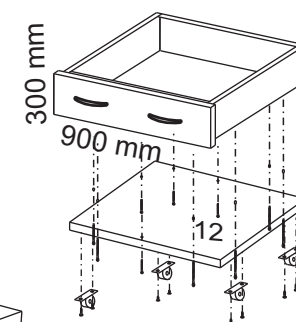
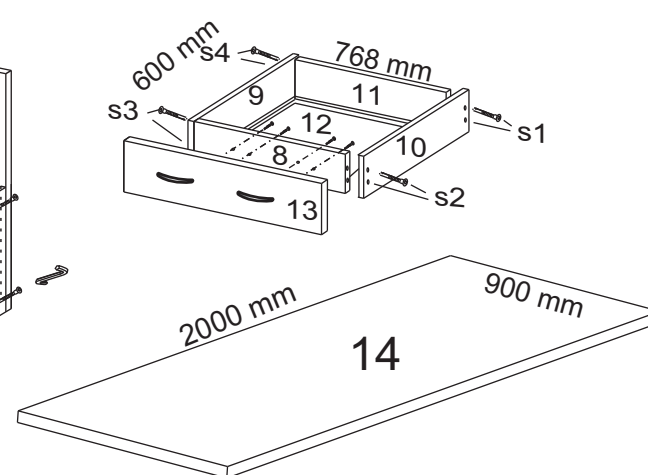
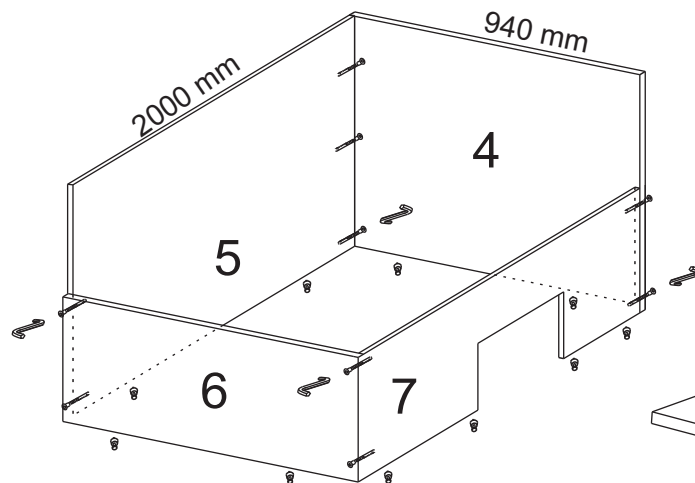
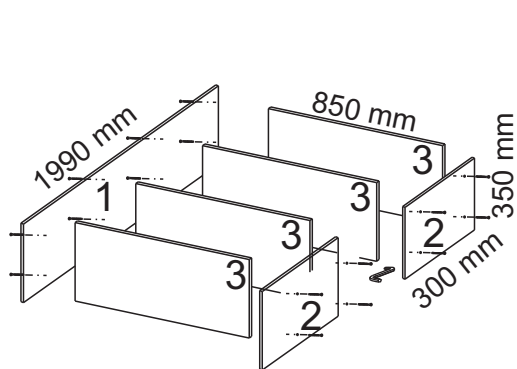
Se prind prin eurosuruburi legaturile de sertar (8,9,10,11) prin gaurile existente (s1,s2,s3,s4). Se prind rolele de capacul sertarului (12), apoi se fixeaza capacul de legaturi prin eurosuruburi. Se prind apoi manerele si fata de sertar (13) de legatura (8) prin suruburi M4x30, apoi se aseaza sertarul sub pat.

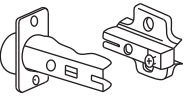
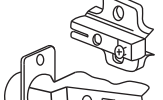
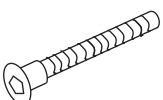
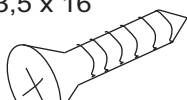

ACCESORII

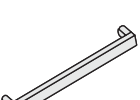
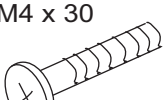
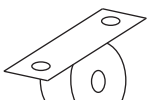
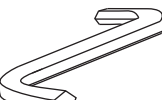
Balama aplicate	Balama semiaplicata	Eurosurub	Holsurub	Picioruse cui	Tinte	Maner	Surub	Rola	Cheie imbus
									
Buc. x 0	x 0	x 43	3,5 x 16 x 8	x 10	x 0	x 2	M4 x 30 x 4	x 4	x 1