

FISA DE MONTAJ

T 7. SUSPENDAT MIC

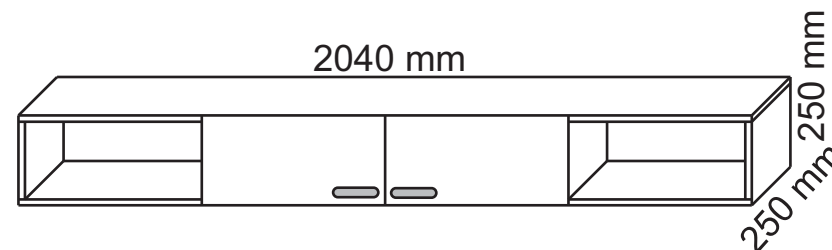

PASUL 1:

Se prind cele doua laterale (1) si (2) si separatorii (5) de capacul (3) in gaurile existente, folosind eurosuruburi si cheia imbus. Apoi se aseaza spatele (6) din PFL in canalele existente pe laterale si separator.

PASUL 2:

Se prinde apoi si capacul (4) de laterale tot prin eurosuruburi.
Se prind manerele de usi (7) folosind suruburile M4x20.

PASUL 3:

Se prind balamalele de usa si contrele de separatorii (5), se realizeaza ansamblul balama-contrabalama reglandu-se usa.
Se prind coltarii agatatori de capacul (4) prin holsuruburi 3.5x16 apoi se fixeaza corpul de perete.

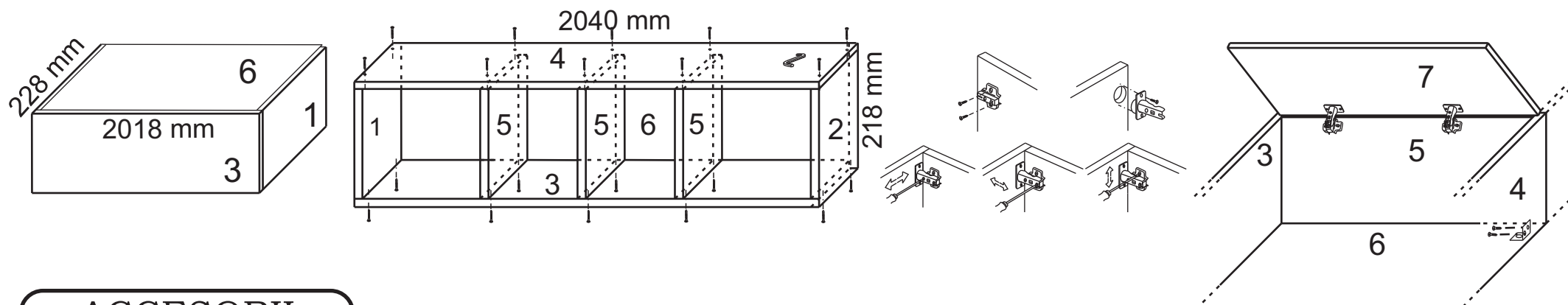

ACCESORII

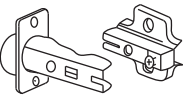
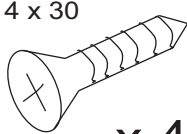
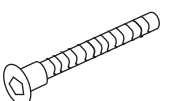
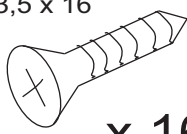
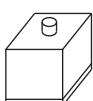
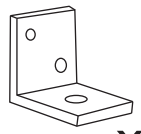
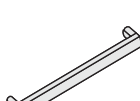
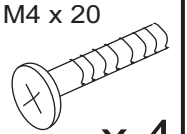
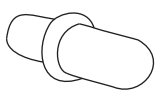
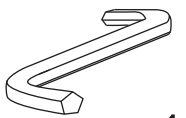
Balama aplicate	Holsurub	Eurosurub	Holsurub	Picioare H50	Coltar agatator	Maner	Surub	Suport polita	Cheie imbus
									
Buc. x 4	4 x 30 x 4	x 20	3,5 x 16 x 16	x 0	x 4	x 2	M4 x 20 x 4	x 0	x 1