

Instructiuni de asamblare  
Assembly instructions

PRODUS : COMODA – DORMITOR RAUL  
PRODUCT : CABINET – BEDROOM RAUL

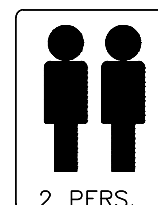

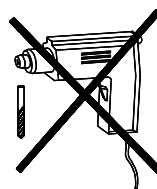
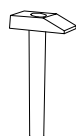
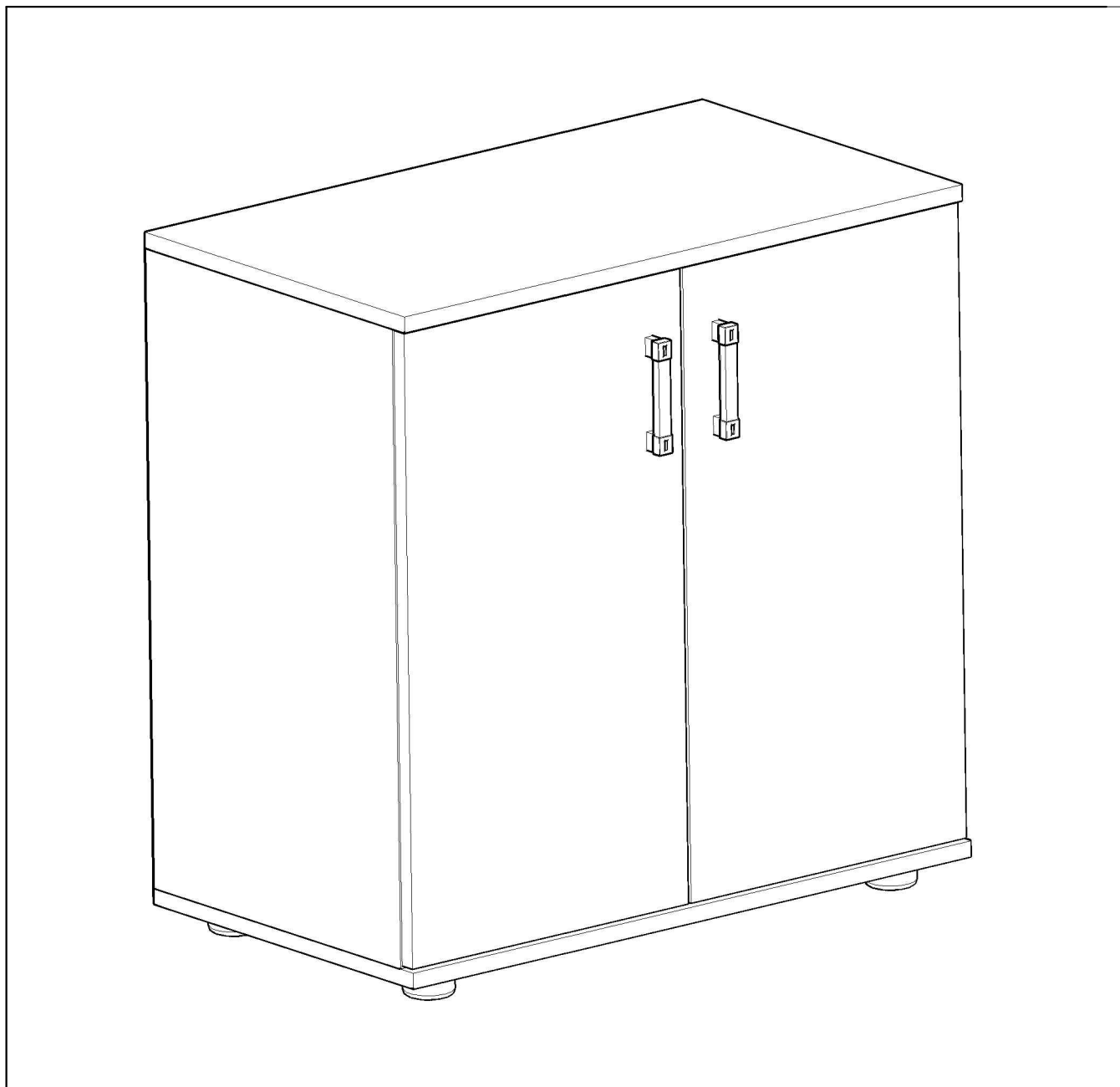
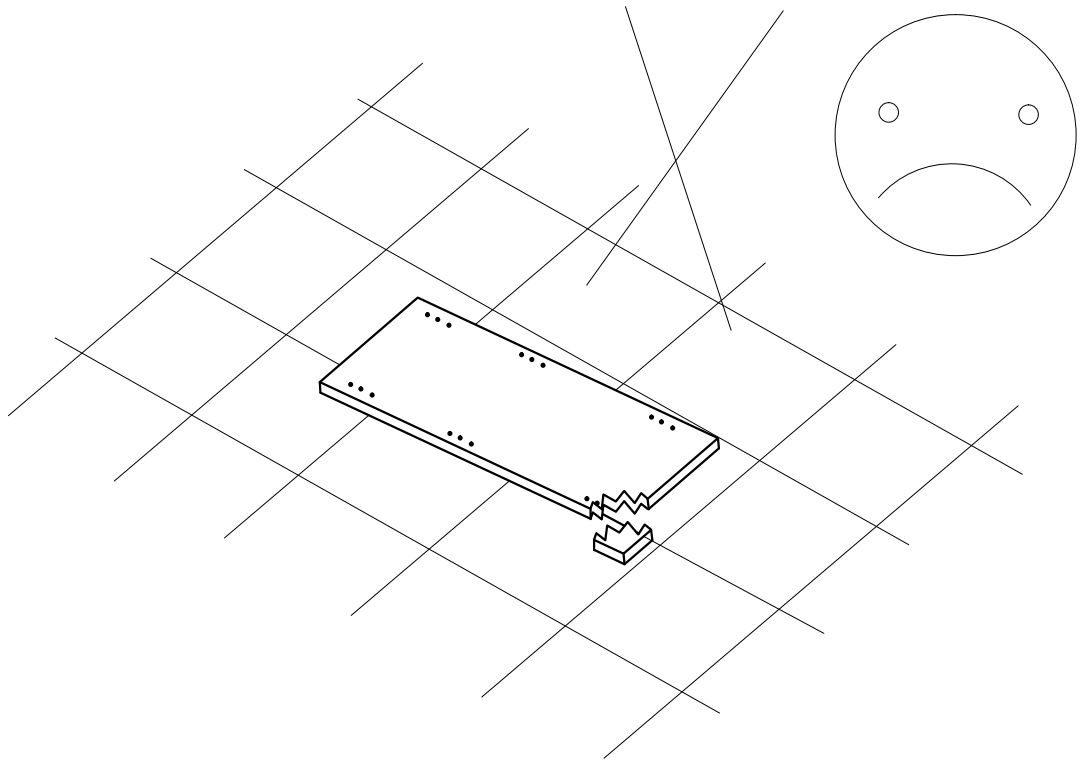
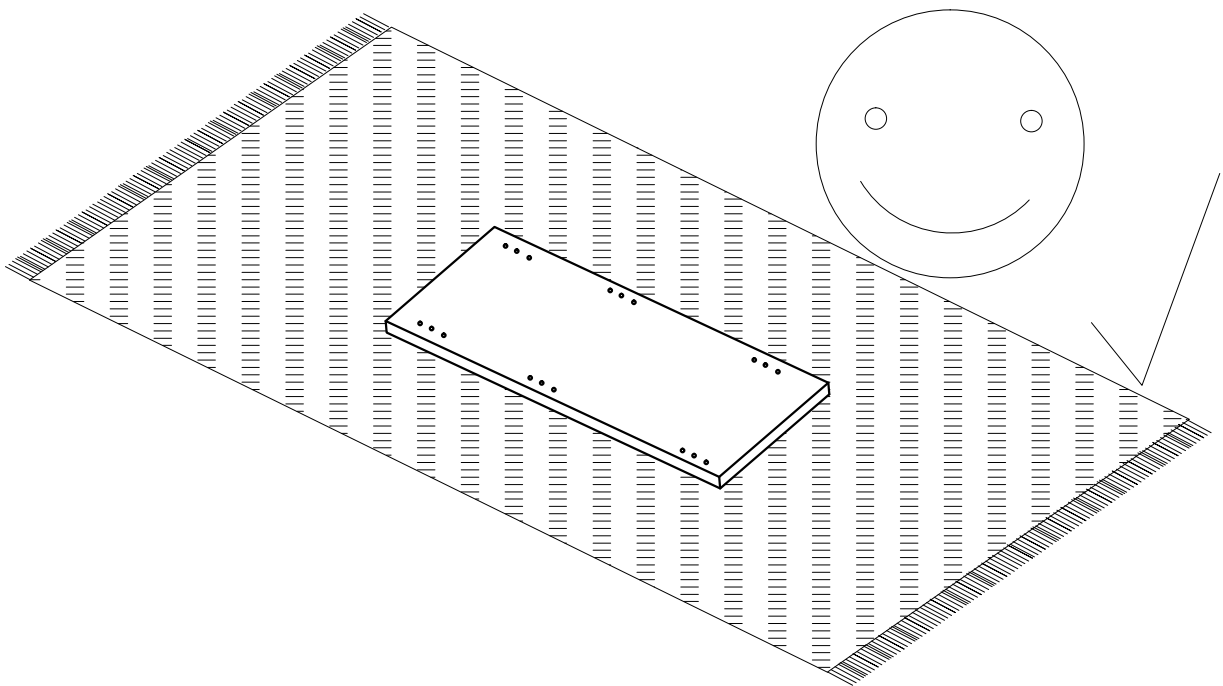

AR

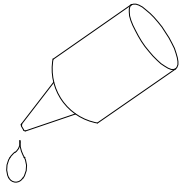

M-07

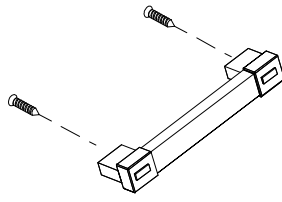

S2-22

ø3.9x22



E-60



E-13



B-01

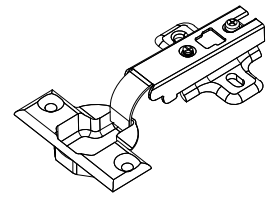

PI-20

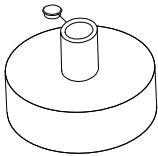

S1-16

ø3.5x16



T-01



D-003



S-001

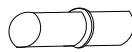

HEX

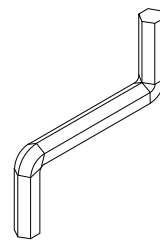

H

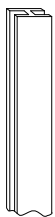

## Caracteristici tehnice produs

A = 700mm

B = 400mm

H = 710mm

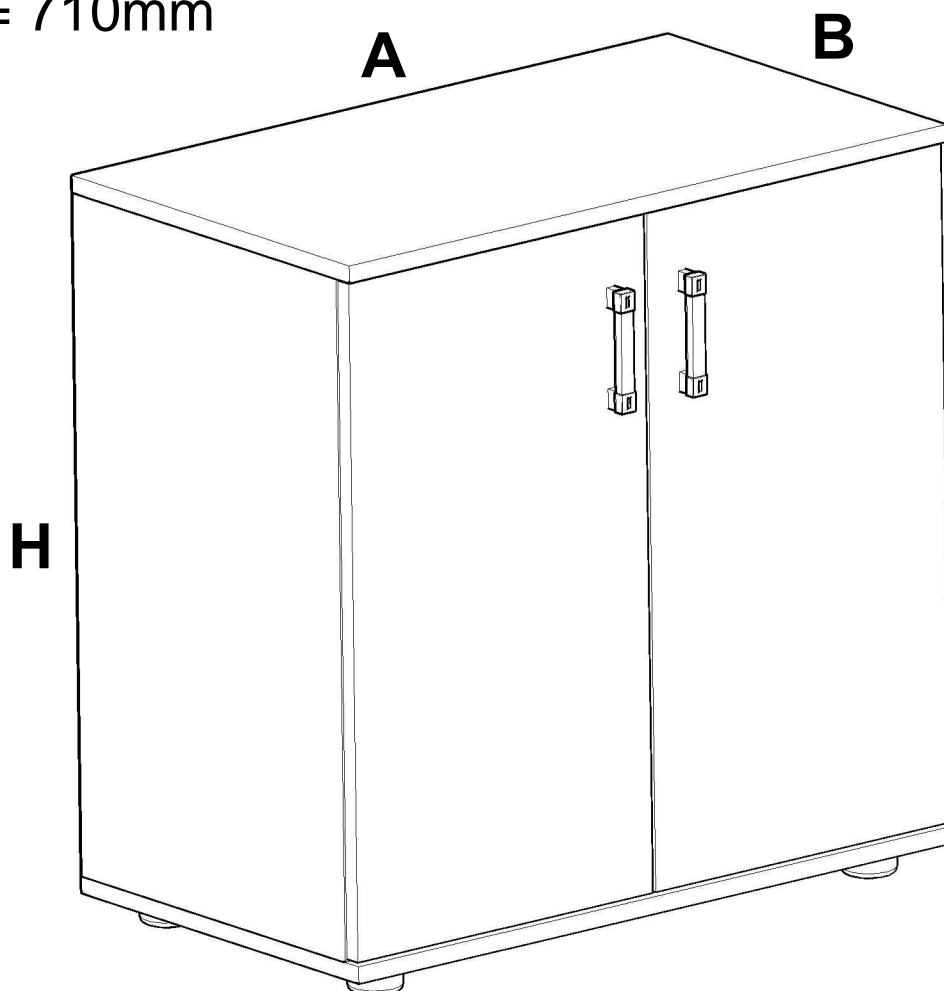

- Materiale:
- Carcase si fronturi din placi din aschii de lemn (PAL) meleminate de grosime = 16 mm
  - Spate corpuri din placi din fibre de lemn de inalta densitate (HDF) de grosime = 3 mm
  - Maner din materiale plastice
  - Cant ABS 0.5 mm
  - Balamale metalice
  - Elemente de imbinare metalice
  - Picioar reglabili din material plastic H=27 mm

650X380.5X16

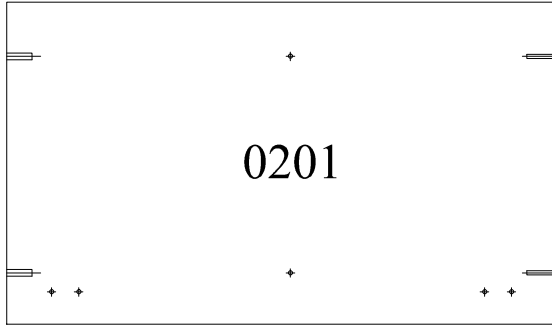

0201

650X380.5X16

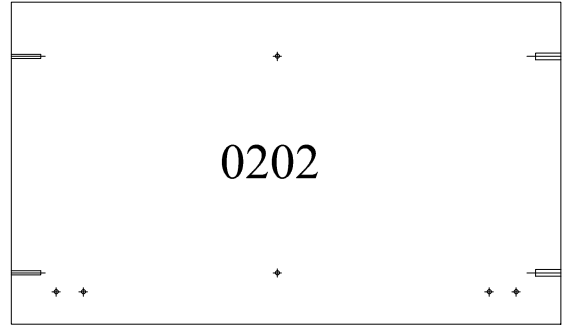

0202

701X400.5X16



0203

701X400.5X16



0204

644X346X16

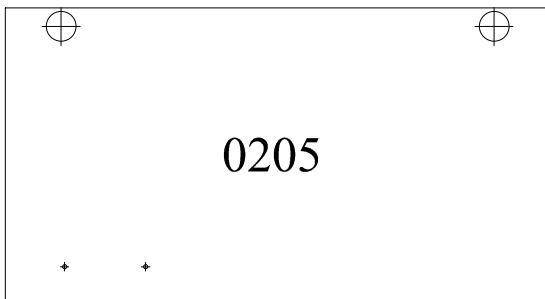

0205

644X346X16

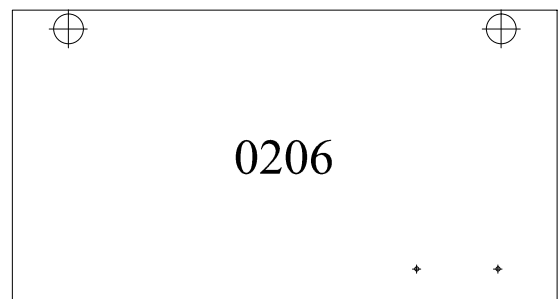

0206

668X350.5X16



0207

2x678x347X3

